

Article

# Object Investigation of Industrial Heritage: The Forging and Metallurgy Shop in Taipei Railway Workshop

Yu-Hsun Chen <sup>1</sup>, Guan-Chen Chen <sup>2,\*</sup>, Ching-Tai Wu <sup>3</sup>, Chi-Lin Lee <sup>4</sup>, You-Rou Chen <sup>3</sup>, Jun-Fu Huang <sup>3</sup>, Kuo-Hung Hsiao <sup>3</sup> and Jong-I Lin <sup>3</sup>

<sup>1</sup> Department of Mechanical Engineering, National Taiwan University of Science and Technology, Taipei 10607, Taiwan; yhchen@mail.ntust.edu.tw

<sup>2</sup> Department of Mechanical and Electro-Mechanical Engineering, Tamkang University, New Taipei City 25137, Taiwan

<sup>3</sup> Collections and Research Division, National Science and Technology Museum, Kaohsiung 80765, Taiwan; tiger\_wu@mail.nstm.gov.tw (C.-T.W.); flyelva1022@gmail.com (Y.-R.C.); junfu@mail.nstm.gov.tw (J.-F.H.); khhsiao@mail.nstm.gov.tw (K.-H.H.); lin@mail.nstm.gov.tw (J.-I.L.)

<sup>4</sup> Department of History, Tamkang University, New Taipei City 25137, Taiwan; 123389@mail.tku.edu.tw

\* Correspondence: gcchen@mail.tku.edu.tw; Tel.: +886-2621-5656 (ext. 2782)

Received: 28 February 2020; Accepted: 27 March 2020; Published: 1 April 2020



**Abstract:** As a special plant for train maintenance in northern Taiwan, the Taipei Railway Workshop was founded in 1885 and moved in 2011, reflecting the changes in Taiwan's history, transportation, and industrial technology. Now, it is planned to change the maintenance plant into a railway museum in the form of an in situ site. This study briefly introduces the historical background and present situation of the Taipei Railway Workshop and takes its forging workshop as the object for investigation and exhibition planning. According to the preservation and maintenance methods of the cultural heritage of the museum, the investigation process proposed includes four steps: Site exploration, object registration, object research, and exhibition planning. The work area in the plant is divided into shaping and forging areas, as based on the categories of the machines on the site of the forging workshop. In this study, a total of 85 industrial relics in the forging workshop are registered for systematic research. The working conditions, including machine parts for train maintenance, manufacturing processes of parts, and the relationship between in-line on-site machines and tools, of the forging workshop before closing are restored, as based on the principles of machine manufacturing, literature, and retired workers' oral histories. Finally, an in situ exhibition plan of the forging workshop is put forward based on the results of the object research.

**Keywords:** industrial site; railway industry; technology history; cultural heritage

## 1. Introduction

The Taipei Railway Workshop was a special plant for train maintenance and modification of Taiwan Railways. The Taipei Railway Workshop shows more than 100 years of Taiwan's history from 1885 to 2011, including the Qing-Ruled Period (1683–1895), the Japanese-Ruled Period (1895–1945), World War II, and the retreat of the government from the Republic of China to Taiwan (1949–now). It has status as both industrial site and cultural heritage, and is of great cultural significance to Taiwan's architecture, science, technology, historical development, labor culture, transportation, and industrial value [1,2].

The Taipei Railway Workshop is the former "Taipei Machinery Bureau", as established in 1885. In the late 19th century, Taiwan was governed by the emperors of the Qing Dynasty, and the

Taipei Machinery Bureau was established under the background of the Westernization Movement to be responsible for the production of weapons and military facilities. In 1895, meaning the early Japanese-Ruled Period, the emperor of the Qing Dynasty ceded Taiwan to Japan, and the Taipei Machinery Bureau established during the Qing Dynasty was taken over by the Japanese army and changed to the “Taipei Artillery Factory”, a place for weapon maintenance of the Japanese army. In 1899, with Taiwan’s West Coast line railway construction plan, the General Governor of Taiwan requested that Japan’s Army Ministry transfer the assets of the Taipei Artillery Factory to the Railway Department of the General Governor to become a maintenance plant for the Railway Department; therefore, the Railway Department of the General Governor of Taiwan established the “Taipei Railway Workshop” in 1900. In 1935, to respond to the growing demands for railway development in Taiwan, the Taipei Railway Workshop was relocated to its present site in Xinyi District, and became the first modern railway maintenance plant in Taiwan. From 1950 to 1970, assisted by the United States, the diesel-electric locomotive shop was newly built in the Taipei Railway Workshop to upgrade train power from steam and diesel engines to electrified power. Until 2012, when Taiwan Railways moved the maintenance base to Fugang (Taoyuan, Taiwan), the Taipei Railway Workshop was faced with the crisis of removal and resale due to the financial problems of the Railway Authority. Finally, it was preserved by the great efforts of cultural heritage groups and railway fans, and designated as a national historical site; moreover, the Ministry of Culture established the Preparatory Committee of the National Railway Museum in 2019 to carry out the core business of cultural relic collection, maintenance, research, and exhibition [1–3].

The Taipei Railway Workshop covers a total area of 193,912 m<sup>2</sup>, including a forging workshop (forging and metallurgy shop), engine room, erecting workshop, diesel-electric locomotive shop, coach workshop, and sheet metal workshop, and is equipped with staff dormitories, employee bathhouse, and other welfare facilities for workers. The plant plan and the aerial view are shown in Figures 1 and 2, respectively [3].

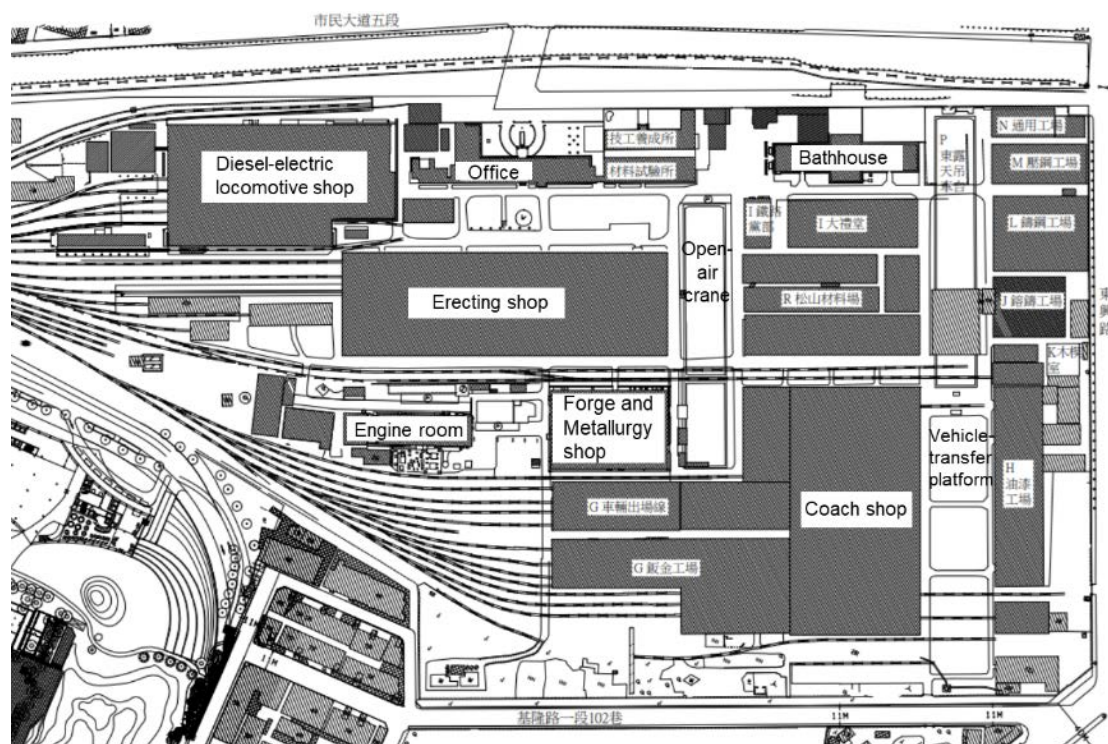
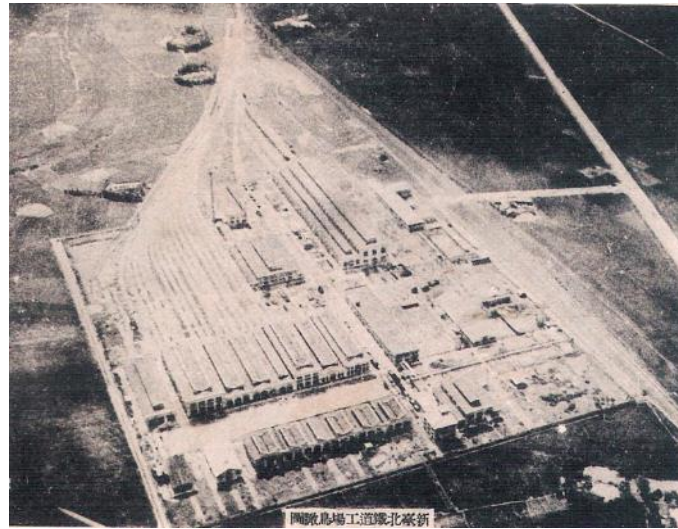


Figure 1. Plan of Taipei Railway Workshop [3].



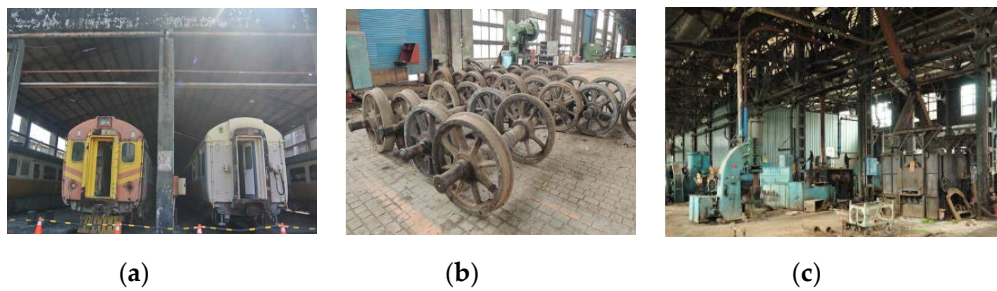
**Figure 2.** View of Taipei Railway Workshop in 1930s [4].

As the Taipei Railway Workshop covers a large area, and has a large number of objects, currently, led by the Ministry of Culture, it is divided into various sections for restoration and to build an in situ museum. The purposes of this study are object research and exhibition planning of the forging workshop. Built in 1935, the forging workshop is the working field for forging and manufacturing, steel heating treatments, spring repair testing, and vehicles maintenance, thus, this area has the oldest mechanical equipment in the Taipei Railway Workshop. Figure 3 shows the working conditions of the forging workshop in the 1950s, and Figure 4 shows the present situations of the three areas of the Taipei Railway Workshop. The purposes of this study are object research and exhibition planning for the forging workshop of the National Railway Museum. Taking the forging workshop as an exhibition space, this study explains the historical background, train technology, and technology development in Taiwan driven by track vehicles.



**Figure 3.** Operations of the forging shop in 1950s [2].

The working area in the forging workshop can be divided into two areas, namely shaping and forging areas. For the former, spring was the main product of the shaping area. It is made of an elastic material and used to relieve shock or vibration, store energy, or measure the amount of force in mechanical devices. Since the middle of the 17th century, the leaf spring has been used on the carriage as a part of suspension [6]. To the 19th century, the leaf springs are also applied on the suspension of the trains, and it was replaced gradually by the helical spring.



**Figure 4.** Present situations of the plant [5]. (a) Sheet metal workshop, (b) erecting workshop, (c) forging workshop.

For the other area in the shop, forging is a manufacturing process in which a metal hammer is used to strike a metal workpiece to generate local compressive force to form the metal. This manufacturing technique can be traced back to thousands of years ago, and the power source of the forging devices had developed from manpower, weight [7], water [8,9], compressed air [9], to the steam and electric power.

This study conducts object inventory, organization, filing, and basic study, and interviews the workers who had been in the forging workshop. By summarizing the study results of object research and worker interviews, the complete information of file data tables of the archaeological survey is deduced and integrated, in order to convert the complex scientific knowledge into language easily understood by viewers. Meanwhile, preservation and maintenance methods are suggested, and the plans for exhibition planning, exhibition outline, promotion, and education activities are proposed [1–5].

## 2. Materials and Methods

With the technological evolution, aeronautical facilities, navigation equipment, and boiler units have appeared in large numbers, and due to their scientific, historical, cultural value and condition, many of them have become important cultural heritage items in museum collections. However, the preservation and maintenance of such large objects have become an urgent problem faced by museums. Many international principles and specifications have been developed for the preservation and maintenance of cultural heritage items, thus, there are many records of industrial site restoration and in situ museum planning [2,9–12].

As a part of the railway museum restoration program of the Ministry of Culture, this study organizes the cultural relics and relevant historical data of the forging workshop. Most of the cultural relics in the plant are machines, including the British 941 steam hammer, which was purchased during the Qing Dynasty in 1889 and is the most representative. In addition to sorting out the historical data of the industrial machine relics one by one, the correlation between machines, operation technology, and suggestions for cultural relic conservation are the main items of this program. Industrial machine relics equipped with electric systems can also be found, such as the machines purchased from Morita Iron Works in 1974, which are related to helical spring production. Although various industrial machine relics were purchased in different years, the display fields are set to match with them according to their functions and the processing requirements. The applications of the machines are also changed to adapt to the newly purchased machines; therefore, in addition to the considerations of the history of the cultural relics, the overall area history is another focus of this study. As shown in Figure 5, this study procedure mainly consists of four items, including site exploration, object selection, numbering and registration, object research, and exhibition planning.

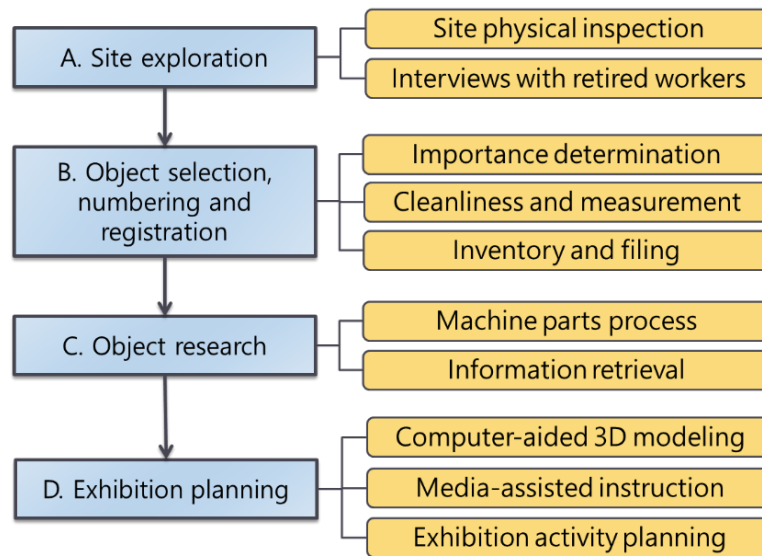


Figure 5. Study procedure.

#### A. Site exploration

The members of the research team included museum researchers, cultural relic restorers, historians, and mechanics. In the first step, the people in this program conducted site explorations of the forging workshop together with the staff of the Taipei Railway Workshop (present Preparatory Office of Railway Museum) and the workers who had maintained the trains in the forging workshop, in order to confirm the current preservation situations of buildings, machines, and peripheral objects on this site.

This research team and the abovementioned staff performed the site exploration on 8 August, 2019. The workers of the forging workshop provided explanations of the site, including the parts they used to produce here, the machine operation modes, and the production processes, as well as the staff's dining and rest experiences, in order to establish the research team's basic understanding of the industrial site.

#### B. Object selection, numbering, and registration

According to the basic understanding, as established in the previous step, this research team selected the objects in the forging workshop. Some on-site items were moved after the relocation of Taiwan Railways, and many fixtures and hand tools were scattered, thus, the research team focused on the manufacturing process of the mechanical components used for train maintenance, in order to select the objects, including machines in the plant, auxiliary tools, and the vehicles used to transport work pieces between machines. The object data, such as names, storage locations, external dimensions, and feature descriptions were listed for important objects, together with the numbers marked in the previous step and photos of the present situations. Furthermore, documents were created for all objects to record the detailed data of the objects, such as the units' location information, the industrial site's nature and cultural significance, investigation numbers, machine or tool labels, manufacture dates, nameplates and marks, constituents and materials, and present situation descriptions.

#### C. Object research

The purpose of this step is to clarify the functions of all machines and tools during the manufacturing process. In addition to the manufacturing procedures of machine parts, the items mainly discussed are the purchase time and usage of machines, as recorded by the Taipei Railway Workshop, in order to clarify the contemporary manufacturing technologies. The machine parts made in the forging workshop were usually made of steel or alloy, as created through various steps, such as

billet finishing, heating, shaping, and testing, and many machines and tools were required to complete the steps in order; for example, clamps were required to put parts into the furnace for heating; cranes or vehicles with rollers were required to convey parts to other machines for subsequent processing after heating. Hence, based on the background knowledge of the machine part manufacturing process, this step connects the relationships between all machines and tools by combining the descriptions of the workers who had worked in this field.

#### D. Exhibition planning

The in situ site museum of the forging workshop was planned based on the investigation results in the first four steps, which is expected to show the historical background and cultural values of the industrial site, as well as the mechanical technology of train maintenance and the workers' life at that time. In this study, mechanical technology is transformed into easy-to-understand descriptions, and the previous production conditions in the plant are graphically explained through 3D models built with the assistance of computers. This study also planned activities to deliver the right information under the premise of considering the degree of interest by viewers. In addition, the visitors are divided into children, the general public, and students and scholars in engineering, and each group was provided with various depths of data.

### 3. Object Investigation

The most important part of a train's moving gear is the bogie, which carries the weight of the body and guides the train to move along the track. A bogie consists of a bogie frame, suspension system, and wheels, as shown in Figure 6. The suspension system is a linking system between the underpinning of the frame and the wheel and has the function of absorbing the kinetic energy of the vibrations, in order that riding comfort is improved [13,14].

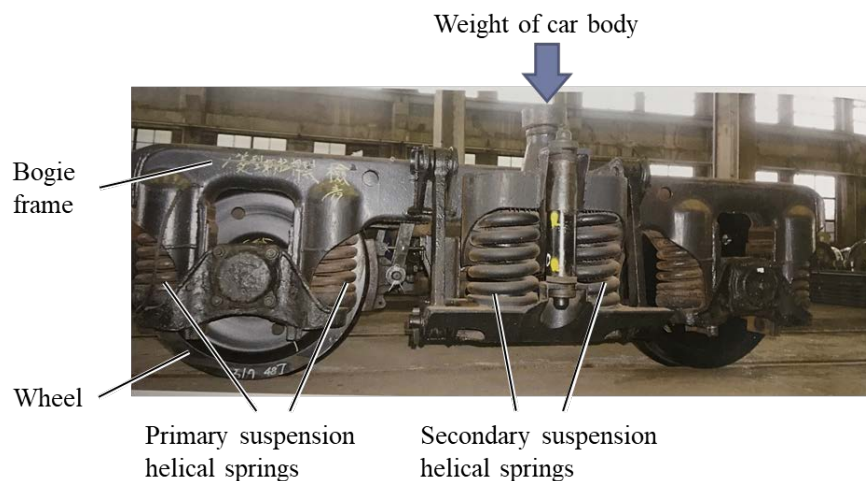
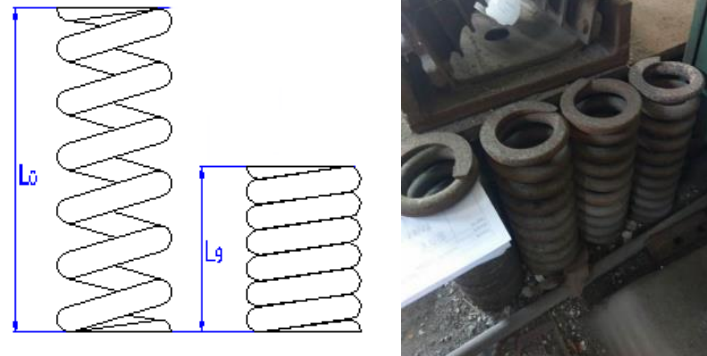


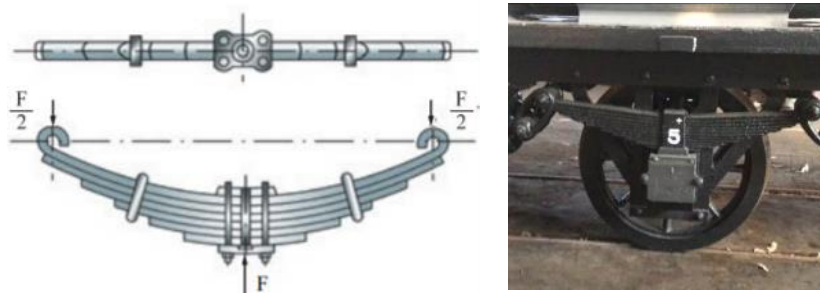
Figure 6. Composition of train bogie [13].

According to the interviewed workers of the forging workshop, leaf springs and helical springs were commonly used for the trains in early times, as shown in Figures 7 and 8. Initially, leaf springs were used for trains; however, due to the poor comfort they provided, helical springs were used instead. As entire trains had to be disassembled for overhaul, it was necessary to replace the springs if helical springs were worn or their error values exceeded the standard. Taiwan Railways used a lot of helical springs, and the manufacturing technology was not difficult; therefore, there was a series of machines used to produce helical springs at the northeast corner of the forging workshop of the Taipei Railway Workshop. After the Electric Multiple Unit (EMU) series trains were imported from the United Kingdom in 1978, almost all of Taiwan Railways' trains were converted to use air springs. On this basis, it can be inferred that the machines in the Taipei Railway Workshop are the representative

production tools transferred by era and technology. At present, the steel springs seen at the Taipei Railway Workshop are only for the maintenance of early trains; for example, Chu-Kuang Express, freight trains, and Fu-Hsing Express in service now still use helical springs.

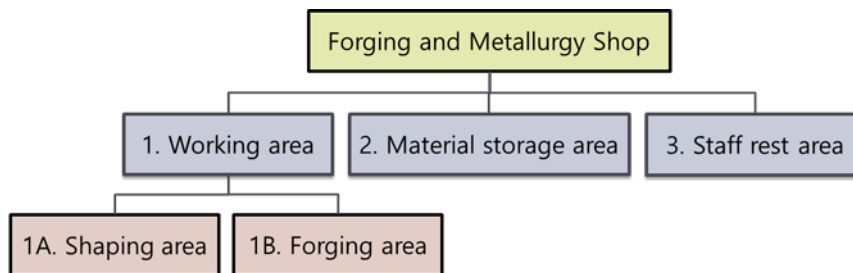


**Figure 7.** Helical spring.

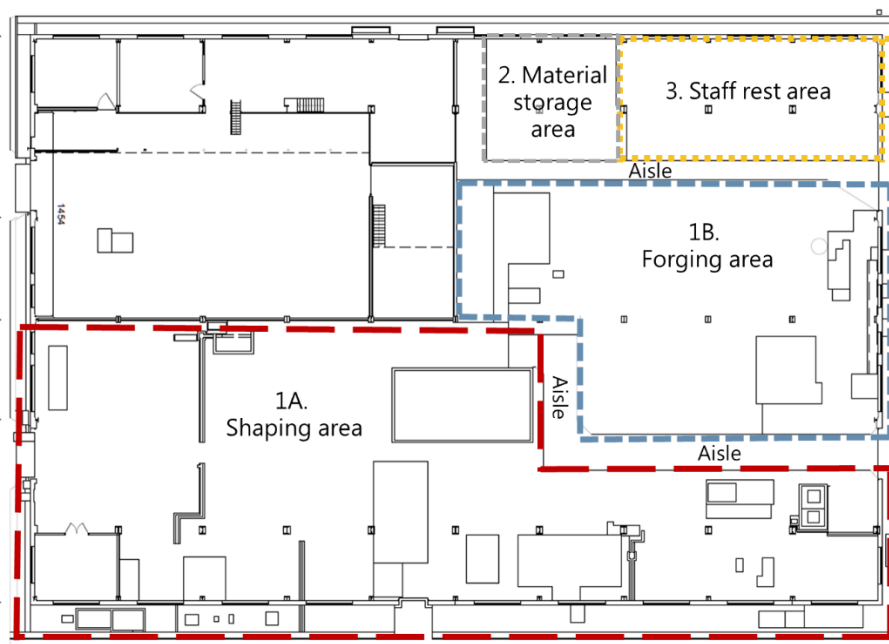


**Figure 8.** Leaf spring.

This study numbered and registered 85 objects, including 41 machines, 30 auxiliary vehicles and working platforms, 12 hand tools and parts, and two other cultural relics. The building of the forging workshop is 60 m long and 40.35 m wide. Based on the features of the machines and objects on site, the forging workshop is divided into three parts: “Working area”, “material storage area”, and “staff rest area”, among which the working area is divided into the “shaping area” and “forging area”, as shown in Figure 9. The shaping area is a working block where machine parts are heated, shaped, and inspected, and mainly has helical spring and leaf spring production lines according to the configurations of the tools and fields of all production lines. The main machines used in the forging area are forging hammers, which can be divided into steam-driven and electric-driven types based on the engines, including the oldest machine steam hammers used in the Taipei Railway Workshop. In addition, there are two parts in the material storage area, one is for storing the raw wire materials used to make machine parts and the other is for storing finished parts. The staff rest area has many tables, chairs, lockers, and hallstands, as well as a shrine to the patron saint of the workshop. The locations of all areas are shown in Figure 10.



**Figure 9.** Classification of exhibition areas.



**Figure 10.** Locations of working blocks in the forging workshop.

### 3.1. Shaping Area

The shaping area is mainly used to manufacture helical springs and leaf springs, which are used for the suspension systems of trains. The manufacturing processes of these two springs, as well as the relevant machines and objects in the forging workshop, are briefly introduced, as follows.

#### 1. Helical springs

The raw material of helical springs (Figure 7) is spring steel wire, and the manufacturing process mainly includes six steps. The relevant machines at all steps in the workshop are shown in Figure 11.

The first step is billet shearing, where the shapes of both ends of the wires used as the billets are adjusted with an inclined rolling mill (A27) after being heating in the furnace (A26). The wires are sheared to the appropriate length with a shearing machine (A22). The machines for billet shearing are shown in Figure 12.



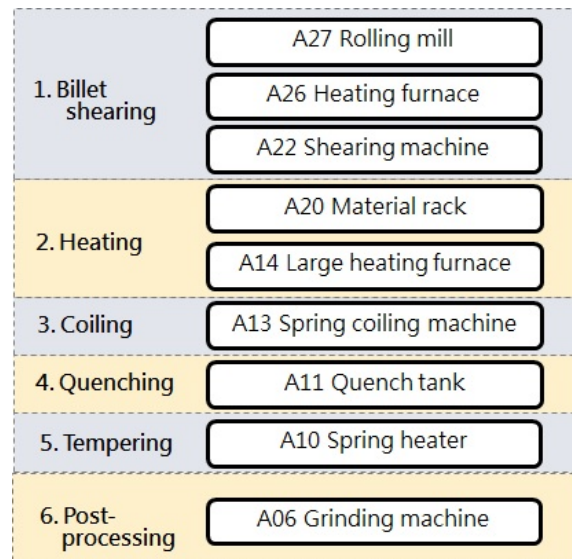


Figure 11. Flowchart of helical spring production line.

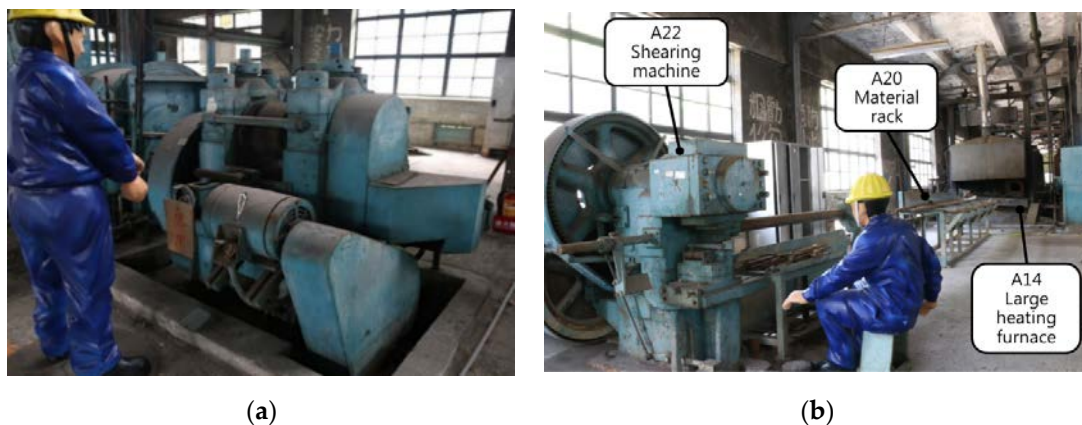
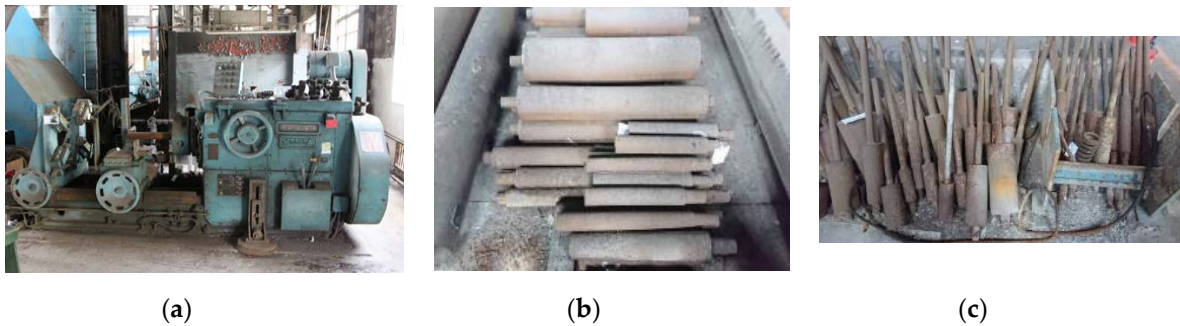


Figure 12. Billet shearing and heating. (a) Inclined rolling mill (A27), (b) shearing machine (A22), material rack (A20), large heating furnace.

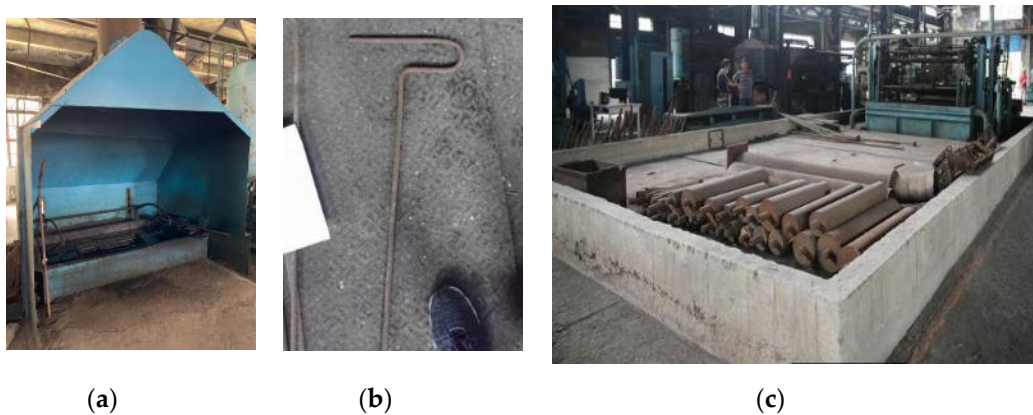
The second step is heating, where the sheared steel pieces are placed on a material rack (A20), and then, put into a large heating furnace (A14). The full length of the large heating furnace is about 85 m, and the furnace temperature is about 500~800 °C. Many motor-driven rollers are equipped in the furnace to convey the billets forward to the outlet to be heated until softened.

The third step is coiling and shaping, where the required spring diameters are selected according to the appropriate spring coiling fixture (A17), in order to wind the softened wires after heating into a spiral shape through a spring coiling machine (A13). If there is any error in the spacing of the shaped springs during manufacturing, hand tools are used to make detailed adjustments. The machines for coiling and shaping are shown in Figure 13.



**Figure 13.** Coiling and shaping. (a) Spring coiling machine (A13), (b) spring coiling fixtures (A17), (c) spring coiling tools (A17).

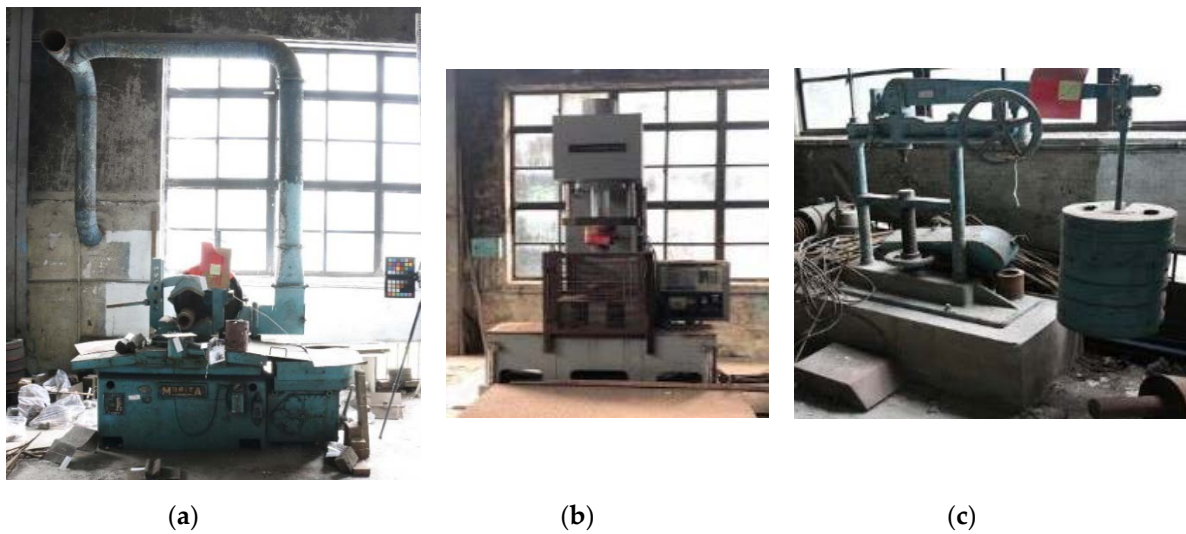
The fourth step is quenching, where the shaped helical springs are immersed in a quench tank (A11) to rapidly cool the spring steels, in order to change the crystallization mode. According to the oral descriptions of the retired workers, peanut oil was once used as the quenchant for helical spring quenching in the Taipei Railway Workshop. The machines for quenching are shown in Figure 14a,b.



**Figure 14.** Quenching and tempering. (a) Quench tank (A15), (b) quench hook, (c) cooling tank (A11-2).

The fifth step is tempering, where the atoms of iron, carbon, and other alloying elements in steel are quickly diffused, rearranged, and recombined, in order to stabilize the steel structure. Hence, reheating the quenched helical springs in a spring heater (A10) for tempering is intended to bring the springs to an appropriate temperature below the lower critical temperature, and then, the spring ends are trimmed. The cooling tank for tempering is shown in Figure 14c.

The sixth step is post-processing, which includes grinding and rust prevention, and the finished springs are tested. Large springs are polished by an end grinding machine (A06), while small springs are directly hammered by hand, and the finished products are tested by a spring testing machine (A04). A hardness tester (A07) was also found in the field; however, as orally described by the retired workers, while this machine was originally intended for spring testing, it was found to be inapplicable. The machines for this step are shown in Figure 15.



**Figure 15.** Post-processing and testing. (a) Grinding machine (A06), (b) spring tester (A04), (c) Vickers hardness tester.

## 2. Leaf springs

The production process of leaf springs (Figure 8) is similar to that of helical springs, as shown in Figure 16, with the same rust prevention, testing, and other post-processing devices.

1. Billet shearing	A32 Steam hammer
2. Heating	A46 Coke furnace
3. Bending	A12 Spring forming machine
4. Quenching	A15 Quench tank
5. Tempering	Forging
6. Assembling	A03 Heating furnace
	A05-2 Strapping machine

**Figure 16.** Flowchart of sheet metal spring production line.

The first step is the billet shearing, where the billets are sheared to the appropriate length with a steam hammer (A32).

The second step is heating, where the sheared leaf spring billets are delivered to the coke furnace (A46) in order to heat the billets until they are soft enough to bend.

The third step is bending and shaping, where the softened billets are bent and shaped by a spring forming machine (A12). The bending length is controlled by a screw on the bender; moving the corresponding nuts by turning the screws with the handle to bend the leaf billets, as shown in Figure 17.

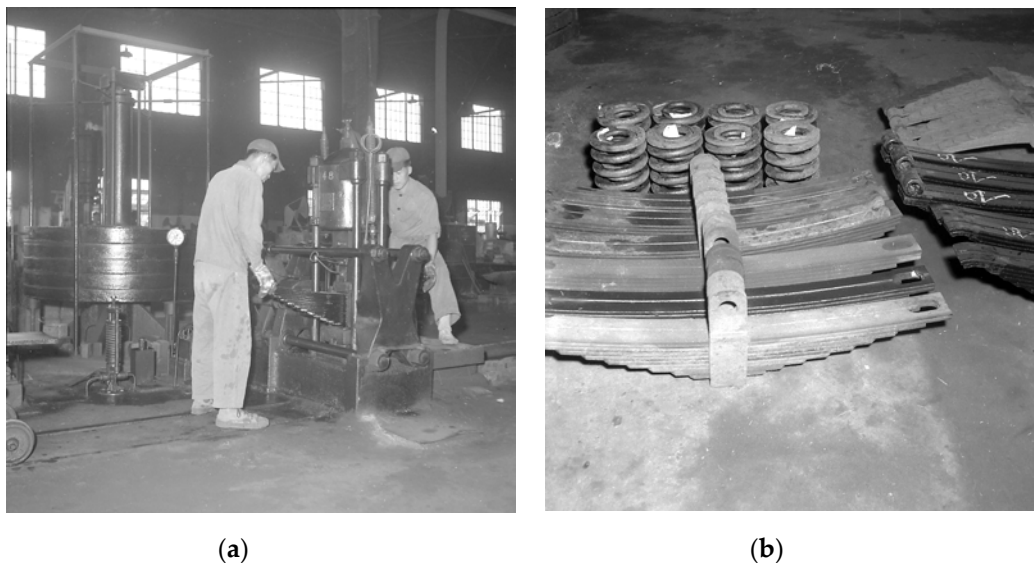


**Figure 17.** Bending, shaping, and assembling. (a) Spring forming machine (A12), (b) strapping machine (A05-2).

The fourth step is quenching, where the formed leaf springs are immersed in a quench tank (A15) to rapidly cool the spring steels.

The fifth step is tempering. The billets are forging to temper themselves.

The sixth step is assembling. A leaf spring is made up of many steel plates with different lengths, all of which are made through the above procedure, and holes are drilled in the center of all plates. Finally, the leaf spring stacks are tightened by a strapping machine (A05-2). An old photo (Figure 18a) shows the assembly of the leaf spring with a specific device. However, this device cannot be found in the forging workshop nowadays. Figure 18b shows both the helical and leaf springs made in the field in 1956.



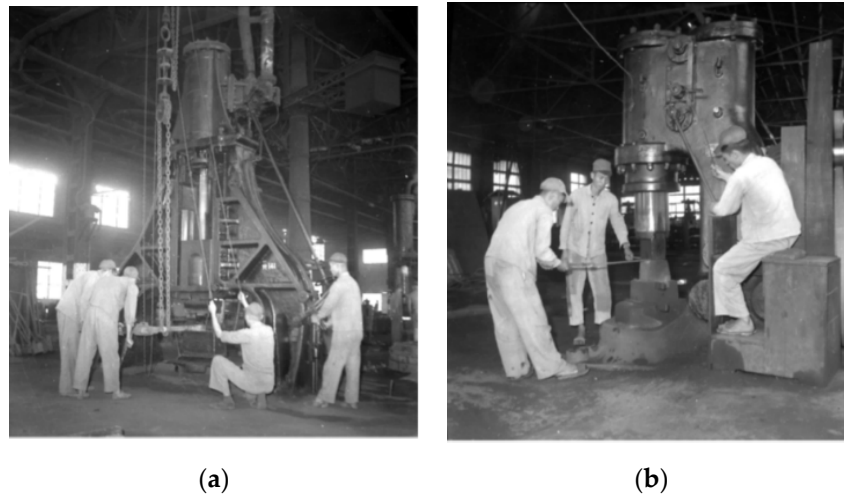
**Figure 18.** Manufacture of the leaf spring (1956) (Courtesy of the Taiwan Railway Administration). (a) Assembly, (b) springs made in the forge shop.

### 3.2. Forging Area

Forging is a manufacturing process to shape billets into machine parts by hammer strikes. Five forging machines in different sizes still remain on the site of the forging shop in Taipei Railway Workshop, and there are many heating furnaces, cranes, pliers, and clamps in the forging area.

In the first step, the billets are clipped with clamps and put in a heating furnace, then the billets are heated to 500–800 °C, in order to soften the steel for shaping. For heavy billets, cranes are used to hang the billets, which convey billets back and forth between heating furnaces and forging machines.

The second step is forging, where parts are forged by steam hammers, forging machines, or workers with hammers, depending on their types. Figure 19 shows the use of steam hammers in the forging workshop in 1956, and it can be seen that many workers cooperated with each other for forging.



**Figure 19.** Forging (1956). (a) Two-ton steam hammer (A45) [2], (b) one-ton steam hammer (A32) [2].

There are five forging machines preserved in the forging shop. Inferring from No. A45 large steam hammer and No. A43 steam hammer with a large crane, they are used to process large objects. Due to low weights, No. A32 and No. A28 steam hammers are used to process small parts. Unlike the four abovementioned steam-driven machines, the other forging machine (A42) is electric-driven and used for mold forging. Figure 20 shows a set of machines for forging manufacture.



**Figure 20.** Current conditions of steam hammers (A45) and cranes (A47).

Among the five forging machines manufactured in Britain in 1889, the No. A32 steam hammer is the oldest machine in the Taipei Railway Workshop and has special research, preservation, and exhibition values. Figure 21 shows the words on the body of the steam hammer, including three important pieces of information. The first one is Rigby's Patent, the second is the production place in Glasgow, and the third is its production number (No. 941). According to literature, this steam hammer was manufactured by Glen & Ross LTD., a British company founded in Greenhead, Glasgow, Scotland in 1856. As a steam hammer manufacturer of considerable scale, the company had so many employees

that it was able to meet the growing number of domestic orders and huge demands for export trades in the 19th century [15,16].



**Figure 21.** Steam hammer manufactured in 1889 (A32).

In the late 19th century, Taiwan began to introduce western machinery and made its own weapons, such as guns and ammunition, and developed its railway system. Under this background, officials at that time had sufficient motivation to buy steam hammers; however, according to the literature now collected, no direct evidence shows that the steam hammer made in 1889 came to Taiwan. Data collection and verification of this steam hammer are also the important goals of the following work.

#### 4. Exhibition Proposal

Authors should discuss the results and how they can be interpreted in perspective of previous studies and of the working hypotheses. The findings and their implications should be discussed in the broadest context possible. Future research directions may also be highlighted.

Based on the investigation of the above objects and the studies on mechanical process technology and historical literature, this study takes the forging workshop as the research object and expects to display the items by in situ exhibition, and describes the technology of the forging workshop, its cultural significance, and the professional spirit of contemporary technicians, according to the production process of the machine parts in the forging workshop. The exhibition planning for the machines, tools, and other cultural relics on the current site mainly includes three parts: Site exhibition, description, and experience activities.

##### A. Site exhibition

In terms of the site exhibition, while the mechanical devices in the forging workshop have been shut down for many years, they have not been damaged, and it is possible for many machines to resume operation. The spring coiling machine (A13) and the forging hammer (A32) are representative of the machines, and are expected to perform manufacturing activities in the in situ exhibition. However, the above studies of the processes show that the helical spring billets must be heated at a high temperature of hundreds centigrade before winding. In addition to workpiece heating, the sound produced during forging is more than 100 decibels; hence, the operation mode must be adjusted to accommodate the performance in the museum. For example, if the wire billets for coiling springs are changed to tin or other soft metal, the cool coils can be directly made without heating, which

can also reproduce the production process and the shapes of the finished products, although the finished products will have none of the functions of shock absorbing springs. In addition, many forging hammers are driven by steam, thus, boilers that produce steam are needed, and fuels, exhaust emissions, and other relevant problems of boilers shall be considered. However, according to the results of the object study, there is a forging machine (A28) driven by electricity, and it will be given priority if demonstration cooperation is required.

#### B. Computer models and animations

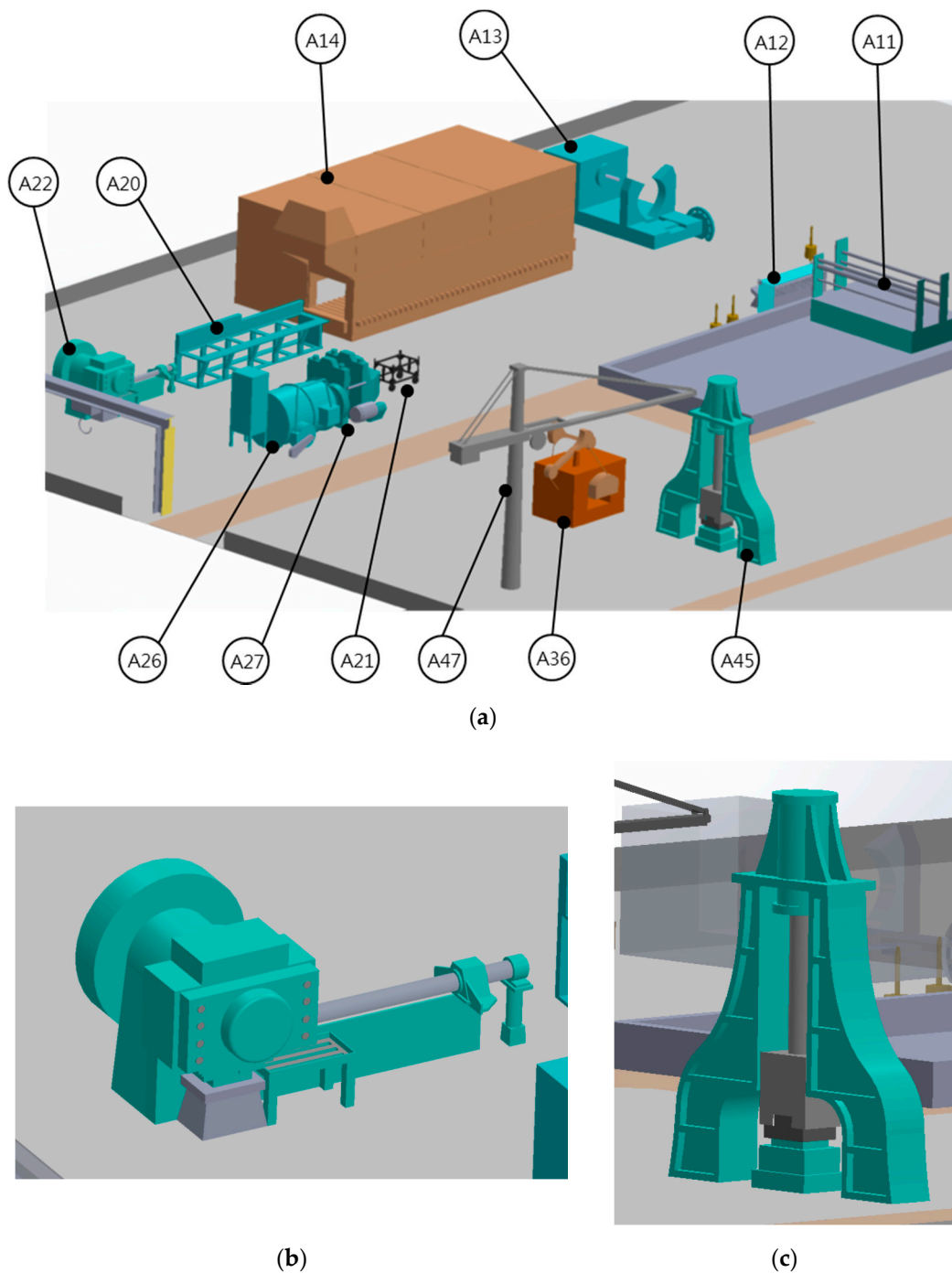
Due to the limitations of machine restoration, the computer-aid techniques had been widely applied to the research and exhibitions of industrial sites, such as 3D reconstruction, animation, and virtual reality. With the help of the techniques, the visitors are able to jump out of a plane perspective and observe the full picture of the field and the details of each machine. Moreover, the analysis in the area of mechanism and materials are also helpful to realize the technology level in the ancient period, and their educational potential is clearly shown [7–12,17–21].

In this study, 3D simulation models are established with the assistance of computers, in order to record the functions, appearances, and locations of the machines and tools in the forging workshop in detail, as shown in Figure 22b,c. Moreover, in cooperation with the historical photo (Figure 19) and the present situations of the workshop (Figure 20), 3D images can also be used for visitors to understand the information of the on-site objects, such as production roles, production procedures, mechanical principles, and operation modes. In this study, the simulation models of the machines are established from the perspective of mechanical engineering, which is helpful to clarify the machines' operational principles and improve the accuracy and rationality of the models, as based on the background knowledge of the mechanical processes. The results will be helpful to the subsequent animation production, which is expected to show reasonable working methods in the workshop, including the animations of mechanical operations and parts production.

#### C. Experience activities

The large machines in the workshop are dangerous in operation, thus, even if they can be restored for demonstration, it is not suitable for visitors to operate practically. Hence, this study intends to make scaled-down machines, and reduce their forces and speeds correspondingly, in order that a miniature table production line can actually work with electricity or air compressors. This activity takes the abovementioned machine parts manufacturing process and the motion relationship between the parts, as clarified by 3D models, as the reference. By operating miniature machines, visitors can experience the original process of the forging workshop to make machine parts.

With various experience activities, in addition to the function of education, the public's understanding of the Taipei Railway Workshop will be enhanced, and public attention and interest in Taipei Railway Workshop will be aroused. Moreover, the public's review rate will be improved according to the experience of various themes in different periods, and cultural heritage can be preserved and sustainably developed.



**Figure 22.** Computer-aided 3D models. (a) Part of machines in shaping area and forging area, (b) shearing machine (A22), (c) steam hammer (A45).

## 5. Conclusions

The Taipei Railway Workshop was in operation from 1885 to 2011, and reflects modern history, railway construction, and the mechanistic technology development processes of Taiwan, and thus, has significant cultural and technological value. After its shutdown, planning started to change the Taipei Railway Workshop from a machine plant to a railway museum; therefore, this study conducts object investigation and exhibition planning for the forging workshop.

In addition to searching literature, this study interviewed retired workers, and focused on the interviewees' working processes in the forging workshop, with particular attention paid to the



manufacturing technology of train bogies and metal springs. Moreover, this study registered 85 items stored in the forging workshop, including machines, tools, and peripheral accessories. Regarding the forged parts, by considering their mechanical manufacturing procedures and cooperating with the site environment, the roles that the machines and peripheral objects played in the production of train parts are connected in accordance with the order of use. Moreover, the experiences and descriptions of site workers are integrated into the object research by referencing the interviews and survey results. In terms of object research, this study clarifies the manufacturing processes of helical springs and leaf springs in the forging workshop, as well as the site, machines, and configurations of spring manufacturing. Regarding the oldest machine, the information about the steam hammer made in 1889 coming to Taiwan is still being traced.

In situ preservation efforts are focused on preservation with the minimum intervention or permanent use. The features of the railway industry in the Taipei Railway Workshop are saved through maintaining, studying, and exhibiting the in situ museum, in order to complement the historical jigsaw of Taiwan's industrial and transportation developments. Moreover, the benefits received from exhibitions and activities will be used to maintain the museum, in order that the life of this industrial site can be sustained and cultural heritages can play their valuable roles and be sustainably managed.

**Author Contributions:** Data curation, C.-T.W., C.-L.L., Y.-R.C., and K.-H.H.; formal analysis, Y.-H.C., G.-C.C., C.-T.W., C.-L.L., Y.-R.C., J.-F.H., and K.-H.H.; funding acquisition, J.-I.L.; investigation, C.-T.W., C.-L.L., and K.H.H.; methodology, Y.-H.C., G.-C.C., and K.H.H.; project administration, G.-C.C., C.-L.L., K.-H.H., and J.-I.L.; resources, J.-F.H. and J.-I.L.; supervision, J.-I.L.; writing—original draft, Y.-H.C.; writing—review and editing, Y.-H.C. and G.-C.C. All authors have read and agree to the published version of the manuscript.

**Funding:** This work is funded by the Ministry of Culture (Taipei, Taiwan) and the Taipei Railway Workshop (Taipei, Taiwan) under the approved document, No. 1081023005, entitled "Investigation and Research on the Forging and Metallurgy Shop and the Engine Room of Taipei Railway Workshop."

**Acknowledgments:** The authors are grateful to the assistance provided by the Taipei Railway Workshop and Taiwan Railway Administration, especially Fugang Vehicle Depot (Taoyuan, Taiwan), Kaohsiung Railway Workshop (Kaohsiung, Taiwan), the respondents Shi-Zhou Lin, Tsan-Huang Liu, Qiu-Long Chen, Ming-Zhou Kang, Jiang-Lang Chen, and Ming-Hsun Hsieh. We would like to thank the following people who participated in this survey: The conservators Jiong-Gang Ruan and Yun-Ru Huang, the scholar Yu-Yu Huang, the assistants Bo-Hong Lin, Hao-Tian Gu, Zhen-Yu Wang, Xuan-Zhan Chen, Jung-Fang Cai, Hong-Yan Gu, Yu-Yan Li, Wan-Rong He, Chia-Ling Chen, Yen-Wen Wang, Yu Tao, Yu-Qi He, Chao-Chen Chang, Cheng-En Lee, and Hsuan-Ming Wang.

**Conflicts of Interest:** The authors declare no conflict of interest.

## References

1. Lu, J.Z. *80 Years of the Taipei Railway Workshop: The Golden Ages of the Railway in Taiwan*; Taiwan Railway Administration: Taipei, Taiwan, 2016. (In Chinese)
2. Lo, S.S. The Research on the History and Industrial Heritage in Taipei Railway Workshop of Taiwan Railways Administration. Master's Thesis, Department of Architecture, Chung Yuan University, Taoyuan, Taiwan, 2011. (In Chinese).
3. Huang, J.M. Project Report of Restoration and Reuse plan on Taipei Railway Workshop. Available online: <https://bit.ly/3ceUiVb> (accessed on 22 January 2020). (In Chinese).
4. Taipei Railway Workshop. Available online: <https://bit.ly/2Px0v1X> (accessed on 15 February 2020).
5. Taipei Railway Workshop (National Railway Museum). Available online: <https://trw.moc.gov.tw/Default> (accessed on 15 February 2020).
6. Landau, D. *Leaf Springs: Their Characteristics and Methods of Specification*; Sheldon Axle Company: Wilkesbarre, PA, USA, 1912.
7. Taddei, M.; Zann, E. *Leonardo's Machines: Secrets and Inventions in the Da Vinci Codice*; Giunti Editore: Milan, Italy; Florence, Italy, 2005.
8. Hsiao, K.-H.; Yan, H.-S. *Mechanisms in Ancient Chinese Books with Illustrations*; Springer: Berlin, Germany, 2014.
9. Rojas-Sola, J.I. Study of ancient forging devices: 3D modelling and analysis using current computer methods. *Tech. Sci.* **2019**, *67*, 377–390.

10. Rojas-Sola, J.I.; De la Morena-de la Fuente, E. Digital 3D reconstruction of Agustín de Betancourt's historical heritage: The dredging machine of the port of Kronstadt. *Virtual Archaeol. Rev.* **2018**, *9*, 44–56.
11. Del Río-Cidoncha, G.; Rojas-Sola, J.I.; González-Cabanes, F.J. Computer-Aided Design and Kinematic Simulation of Huygens's Pendulum Clock. *Appl. Sci.* **2020**, *10*, 538. [[CrossRef](#)]
12. Pardo, C.J. Application of Digital Techniques in Industrial Heritage Areas and Building Efficient Management Models: Some Case Studies in Spain. *Appl. Sci.* **2019**, *9*, 4420. [[CrossRef](#)]
13. Hung, C.W. All Vehicles in Taipei Railway Administration: Illustration of the Bogies of the Passenger Trains. Self-publishing. 2019; ISBN 9789574364930.
14. Okamoto, I. Railway Technology Today 5: How Bogies Work. *Jpn. Railw. Transp. Rev.* **1998**, *18*, 52–61.
15. Carstairs, A.M. Scottish Industrial History: A Miscellany. *Econ. Hist. Rev.* **1979**, *32*, 275. [[CrossRef](#)]
16. Mayer, J. *Notices of Some of the Principal Manufactures of the West of Scotland; The Engineering and Shipbuilding Industries*: Glasgow, UK, 1876.
17. Villar-Ribera, R.; Abad, F.H.; Rojas-Sola, J.I.; Hernández-Díaz, D. Agustín de Betancourt's telegraph: Study and virtual reconstruction. *Mech. Mach. Theory* **2011**, *46*, 820–830. [[CrossRef](#)]
18. Rojas-Sola, J.I.; De la Morena-De la Fuente, E. Agustín de Betancourt's Optical Telegraph: Geometric Modeling and Virtual Reconstruction. *Appl. Sci.* **2020**, *10*, 1857. [[CrossRef](#)]
19. Rojas-Sola, J.I.; De la Morena-De la Fuente, E. The Hay Inclined Plane in Coalbrookdale (Shropshire, England): Geometric Modeling and Virtual Reconstruction. *Symmetry* **2019**, *11*, 589. [[CrossRef](#)]
20. Rojas-Sola, J.I.; De la Morena-De la Fuente, E. Geometric Modeling of the Machine for Cutting Cane and Other Aquatic Plants in Navigable Waterways by Agustín de Betancourt y Molina. *Technologies* **2018**, *6*, 23. [[CrossRef](#)]
21. Rojas-Sola, J.I.; Aguilera-García, Á. Virtual and augmented reality: Applications for the learning of technical historical heritage. *Comput. Appl. Eng. Educ.* **2018**, *26*, 1725–1733. [[CrossRef](#)]



© 2020 by the authors. Licensee MDPI, Basel, Switzerland. This article is an open access article distributed under the terms and conditions of the Creative Commons Attribution (CC BY) license (<http://creativecommons.org/licenses/by/4.0/>).