

# Interaction dynamics of a high-speed train moving on multi-span railway bridges with support settlements

J.D. Yau<sup>1</sup>, L. Fryba<sup>2</sup>

<sup>1</sup>Department of Architecture, Tamkang University  
New Taipei City, Taiwan  
e-mail: [jdyau@mail.tku.edu.tw](mailto:jdyau@mail.tku.edu.tw)

<sup>2</sup>Institute of Applied and Theoretical Mechanics, ASCR,  
Prague, Czech of Republic

## Abstract

After construction of rail bridges, differential support settlement at bridge foundations is one of the key issues being considered for running safety of trains and operation of railways. In this paper, the influence of ground settlement on dynamic interactions of train-bridge system will be studied. The train is simulated as a sequence of identical sprung mass units with equal intervals and the bridge system as a series of simple beams with identical properties. To resolve the train-induced vibrations of a beam structure with support settlements, the total beam response is decomposed into two parts: the *static* response due to vertical support settlement and the *dynamic* component caused by inertia effect of beam vibration. An exact solution for *static* displacement is presented by exerting the support displacements on the beam statically. Thus the remaining dynamic response of the vehicle/bridge coupling system can be computed by conventional vehicle-bridge interaction dynamic method. From the present study, the numerical results indicate that the inclusion of ground settlement is generally small on the bridge response, but it can amplify drastically the vertical response of the moving train. This conclusion is of significance in planning a rail route that has to cross a region with ground subsidence.

## 1 Introduction

Differential support settlement at bridge foundations is one of the key issues being considered for running safety of trains and operation of railways. In this study, a train is simulated as a sequence of equally spaced moving sprung mass units. The multi-span bridge system is modeled as a series of simply supported beams with identical spans. To resolve the dynamic problem for a simple beam undergoing vertical support settlement, the total response of the beam is decomposed into two parts: the *static* response due to support settlement and the *dynamic* component due to inertial effect of beam vibration [1,2]. An exact solution for *static* displacement is presented by exerting the support displacements on the simple beam statically [3]. The remaining interaction vibration of train-bridge system was solved by Galerkin's method and then computed using a comprehensive iterative procedure with Newmark's finite difference scheme [4]. Numerical studies indicate that the inclusion of differential settlement is generally small on the bridge response, but it can amplify drastically the vertical response of a traveling train at various speeds. Such a fact should be taken into account in the design of high-speed railway bridges, especially for the rail route that has to cross the region with concave-up settlement profile.

## 2 Problem formulation

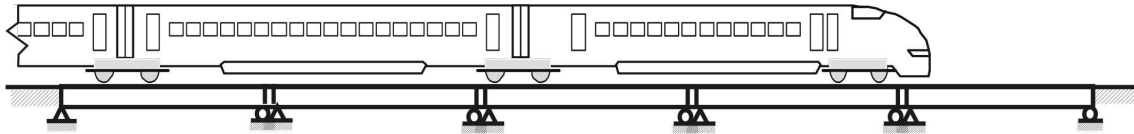

Figure 1: Multi-span railway bridges traveled by a high-speed train.

### 2.1 Basic considerations

Figure 1 shows a train with *equally-spaced* bogie-sets is crossing a series of railway bridges, in which two adjacent car bodies are articulated on a common bogie-set. To simplify the formulation of equations of motion for the vehicle-bridge interaction system in an analytical way, only vertical motions of the dynamic model are considered in this study. The following are the assumptions adopted for the vehicle-bridge system: (1) The multi-span bridges are modeled as a series of simply supported bridges with identical properties; (2) The bridge is idealized as a linear elastic Bernoulli-Euler beam with uniform section; (3) For the regular feature of *equally-spaced* bogie-sets, the train is simulated as a sequence of identical sprung mass units with equal intervals; (4) The dynamic response of continuous tracks is similar to that of the bridge deck due to the strong constraining effect of the ballast layer [1]; (5) The moving wheel-set supporting the bogie-set with a lumped mass  $m_1$  is modeled as an *un-sprung* mass directly rolling on the bridge deck as it moves on the surface of the bridge deck; (6) According to the design specification in Ref. [5], allowable angular distortion between any two points along a bridge span due to ground settlement should not exceed 1/1000.

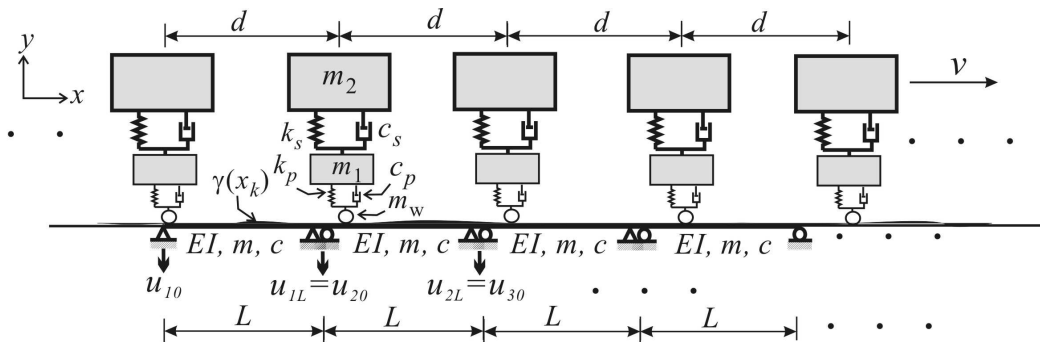

Figure 2: A train model moving on multi-span simple beams undergoing support settlement.

### 2.2 Governing equations

As shown in Figure 2, a sequence of identical sprung mass units with equal intervals  $d$  is moving on a series of simple beams at constant speed  $v$ . Each sprung mass unit consists of two concentrated masses, with the top one representing the mass ( $m_2$ ) lumped from the half of a car body, and the bottom one modeling the concentrated mass ( $m_1$ ) of the bogie-set supported by an *un-sprung* mass ( $m_w$ ) directly running on the surface of the beam deck. The two masses are connected by a set of spring-dashpot system that serves to represent the vehicle's suspension and energy dissipation mechanism. Here, we shall use the following symbols to denote the properties depicted in Figure 1:  $m$  = beam mass per unit length,  $c$  = beam damping per unit length,  $EI$  = flexural rigidity,  $m_w$  = lumped mass of moving wheel,  $m_1$  = lumped mass of the bogie-set, and  $m_2$  = lumped mass of half of a car body. Including the differential settlement on bridge

supports, one can formulate the equation of motion for the  $j$ -th simple beam carrying multiple moving sprung mass units as follows:

$$m\ddot{u}_j(x,t) + c\dot{u}_j(x,t) + EIu_j''''(x,t) = p(x,t) - \mu_j(x,t), \quad (1)$$

$$p(x,t) = \sum_{k=1}^N p_0 \varphi_j(x,t), \quad (2)$$

$$\mu_j(x,t) = \sum_{k=1}^N (m_1 \ddot{y}_{1k} + m_2 \ddot{y}_{2k} + m_w \ddot{u}_j(x_k, t)) \varphi_j(x,t), \quad (3)$$

$$\varphi_j(x,t) = \delta(x - x_k) \left[ H\left(t - t_k - \frac{(j-1)L}{v}\right) - H\left(t - t_k - \frac{jL}{v}\right) \right] \quad (4)$$

with the following non-homogeneous boundary conditions for vertical support settlement [29]:

$$u_j(0,t) = u_{j0}, u_j(L,t) = u_{jL}, \quad EIu_j''(0,t) = EIu_j''(L,t) = 0, \quad (5)$$

where  $(\bullet)' = \partial(\bullet)/\partial x$ ,  $(\dot{\bullet}) = \partial(\bullet)/\partial t$ ,  $u_j(x, t)$  = vertical deflection of the  $j$ -th span,  $\mu_j(x, t)$  = inertial force induced by the vibrating sprung mass units running on the  $j$ -th beam,  $L$  = span length,  $p_0$  = lumped weight of a vehicle model =  $-(m_1 + m_2 + m_w)g$ ,  $g$  = gravity acceleration,  $\delta(\bullet)$  = Dirac's delta function,  $H(t)$  = unit step function,  $k = 1, 2, 3, \dots, N$ -th moving load on the beam,  $t_k = (k - 1)d/v$  = arrival time of the  $k$ -th load into the beam,  $x_k$  = position of the  $k$ -th load along the beam,  $y_{1k}$  = vertical displacement of the  $k$ -th lumped mass  $m_1$ ,  $y_{2k}$  = vertical displacement of the  $k$ -th lumped mass  $m_2$ ,  $u_{j0}$  = vertical settlement at  $x = 0$  of the  $j$ -th beam, and  $u_{jL}$  = vertical settlement at  $x = L$  of the  $j$ -th beam. The equations of motion for the  $k$ -th sprung mass unit are given by

$$\begin{bmatrix} m_1 & 0 \\ 0 & m_2 \end{bmatrix} \begin{Bmatrix} \ddot{y}_{1k} \\ \ddot{y}_{2k} \end{Bmatrix} + \begin{bmatrix} c_p + c_s & -c_s \\ -c_s & c_s \end{bmatrix} \begin{Bmatrix} \dot{y}_{1k} \\ \dot{y}_{2k} \end{Bmatrix} + \begin{bmatrix} k_p + k_s & -k_s \\ -k_s & k_s \end{bmatrix} \begin{Bmatrix} y_{1k} \\ y_{2k} \end{Bmatrix} = \begin{Bmatrix} f_{vk} \\ 0 \end{Bmatrix} \quad (6)$$

$$f_{vk} = k_p [u_j(x_k, t) + \gamma(x_k)] + c_p \dot{u}_j(x_k, t), \quad (7)$$

in which  $c_p$  = primarily damping, and  $k_p$  = primarily stiffness,  $c_s$  = secondary damping, and  $k_s$  = secondary stiffness,  $f_{vk}$  = interaction force existing between the beam and the wheel mass of the  $k$ -th moving oscillator, and  $\gamma(x_k)$  = rail irregularity (vertical profile)..

### 3 Solution methods

As the beam equation shown in Eqs. (1) and (5), it is a differential equation associated with non-homogeneous boundary conditions. The total deflection response  $u_j(x,t)$  for the  $j$ -span of the multi-span beams undergoing vertical support settlement can be decomposed into two parts: the *static* displacement  $U_j(x)$  and the *dynamic* deflection  $u_{dj}(x, t)$  [1,2], or

$$u_j(x,t) = U_j(x) + u_{dj}(x,t) \quad (8)$$

Here,  $U_j(x)$  represents the structure displacement caused by *relative* support settlement, and  $u_{dj}(x,t)$  the *dynamic* deflection due to inertia effect of structure vibration [1,2]. By using the decomposition concept of Eq. (8), substituting Eq. (8) into Eq. (1), and discarding all the dynamic terms and external loads, the static equation of equilibrium and the *non-homogeneous* boundary conditions of the beam can be written as follows:

$$EI \frac{\partial^4 U_j}{\partial x^4} = 0. \quad (9)$$

$$U_j(0) = u_{j0}, U_j(L) = u_{jL}, \quad EIU_j''(0) = EIU_j''(L) = 0. \quad (10)$$

Solving the fourth order equation of Eq. (9) associated with the boundary conditions of Eqs. (10) yields

$$U_j = u_{j0} + (u_{jL} - u_{j0}) \times x / L. \quad (11)$$

The *static* displacement shown in Eq. (11) represents the *rigid body* displacements of the  $j$ -th beam undergoing vertical support settlement. Furthermore, introducing Eqs. (8) and (11) into Eq. (1), the equation of motion for the  $j$ -th simple beam is converted into the following vibration equation in terms of *dynamic* deflection  $u_{dj}(x, t)$ :

$$m\ddot{u}_{dj}(x, t) + c\dot{u}_{dj}(x, t) + EIU_{dj}''''(x, t) + \mu_j(x, t) = p(x, t). \quad (12)$$

Since the static displacement  $U_j(x)$  in Eq. (11) has satisfied the boundary conditions with vertical settlements shown in Eqs. (5), the introduction of Eqs. (8) and (10) into Eqs. (5) yields the following *homogeneous* boundary conditions for the dynamic deflection  $u_{dj}(x, t)$ :

$$u_{dj}(0, t) = u_{dj}(L, t) = 0, \quad EIU_{dj}''(0, t) = EIU_{dj}''(L, t) = 0. \quad (13)$$

Obviously, the response of *dynamic* deflection  $u_{dj}(x, t)$  in Eq. (12) associated with the homogeneous boundary conditions in Eqs. (13) can be solved by Galerkin's method [13-15] and computed by Newmark method [4] in the time domain. First, multiplying both sides of Eq. (12) with respect to the variation of the dynamic deflection ( $\delta u_{dj}$ ), and then integrating the equation over the beam length  $L$ , one can obtain the following virtual work equation:

$$\int_0^L (m\ddot{u}_{dj}(x, t) + c\dot{u}_{dj}(x, t) + EIU_{dj}''''(x, t) + \mu_j(x, t)) \delta u_{dj} dx = \int_0^L p(x, t) \delta u_{dj} dx, \quad (14)$$

According to the homogeneous boundary conditions shown in Eqs. (13), the dynamic deflection ( $u_{dj}$ ) of a simple beam can be approximated by a series of sinusoidal functions:

$$u_{dj}(x, t) = \sum_{n=1} q_{jn}(t) \sin \frac{n\pi x}{L}, \quad (15)$$

where  $q_{jn}(t)$  means the generalized coordinate associated with the  $n$ -th assumed mode of the  $j$ -th span. Substituting Eq. (15) into Eq. (14) yields the following generalized equation of motion for the  $n$ -th *dynamic* system of the  $j$ -th beam:

$$m\ddot{q}_{jn} + c\dot{q}_{jn} + k_n q_{jn} + \Gamma_{jn}(t) = p_{jn}(t), \quad (16)$$

where  $k_n = EI(n\pi/L)^4$  = generalized stiffness associated with the  $n$ th generalized system for a simple beam, and

$$p_{jn}(t) = \sum_{k=1}^N F_k(\varpi_n, v, t), \quad (17)$$

$$\Gamma_{jn}(t) = \sum_{k=1}^N [F_{vk}(\varpi_n, v, t) + F_{wk}(\varpi_n, v, t)], \quad (18)$$

The generalized forces of  $F_k(\varpi_n, v, t)$ ,  $F_{vk}(\varpi_n, v, t)$  and  $F_{wk}(\varpi_n, v, t)$  with respect to the  $k$ -th sprung mass unit are respectively expressed as

$$\begin{aligned}
 F_k(\bar{\omega}_n, v, t) &= \frac{2p_0}{L} \psi_{jn}(\bar{\omega}_n, t), \\
 F_{vk}(\bar{\omega}_n, v, t) &= \frac{2(m_1 \ddot{y}_{1k} + m_2 \ddot{y}_{2k})}{L} \psi_{jn}(\bar{\omega}_n, t),
 \end{aligned}
 \tag{19a-c}$$

$$F_{wk}(\bar{\omega}_n, v, t) = \frac{2m_w}{L} \left( \sum_{n=1} \ddot{q}_{jn}(t) \sin \frac{n\pi x_k}{L} \right) \times \psi_{jn}(\bar{\omega}_n, t),$$

$$\psi_{jn}(\bar{\omega}_n, t) = \sin(\bar{\omega}(t - t_k)) \times \left[ H\left(t - t_k - \frac{(j-1)L}{v}\right) - H\left(t - t_k - \frac{jL}{v}\right) \right],
 \tag{20}$$

where  $\bar{\omega}_n (= n\pi v / L)$  = the driving frequency of the  $k$ -th moving load to the  $n$ -th mode of a simple beam. It is noted that the inertial force term of  $\Gamma_{jn}(t)$  shown in Eq. (18) is a key issue making all the generalized beam system and vehicle's equations coupled together due to the presence of  $F_k(\bar{\omega}_n, v, t)$  and  $\sum_{n=1} \ddot{q}_{jn}(t) \sin(n\pi x_k / L)$ , the second term of which is related to all the shape functions used in response analysis of the beam.

To compute the dynamic response of vehicle-bridge interactions for a beam undergoing support settlements, an incremental-iterative procedure needs to be carried out [6]. The numerical procedure of incremental-iterative dynamic analysis conventionally involves three phases: predictor, corrector, and equilibrium checking. In performing the dynamic response analysis of structures containing support settlements, two sets of structure responses were computed each for the pseudo-static response and for the inertia-dynamic response. Detailed information for nonlinear VBI dynamic analysis is available in references [1,2].

### 4 Numerical studies

Figure 2 shows that a number of identical sprung mass units with equal intervals  $d$  are crossing a series of simply supported beams at constant speed  $v$ . To account for the random nature and characteristics of rail irregularity in practice, the following *power spectrum density* (PSD) function [4] is given to simulate the vertical profile of track geometry variations

$$S(\Omega) = \frac{A_v \Omega_c^2}{(\Omega^2 + \Omega_r^2)(\Omega^2 + \Omega_c^2)}
 \tag{21}$$

where  $\Omega$  = spatial frequency, and  $A_v$ , ( $= 1.5 \times 10^{-7}$  m),  $\Omega_r$ , ( $= 2.06 \times 10^{-6}$  rad/m), and  $\Omega_c$  ( $= 0.825$  rad/m) are relevant parameters.

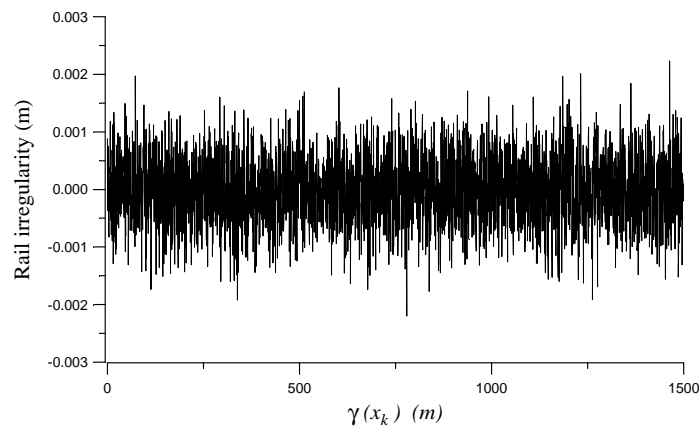

Figure 3: Rail irregularity.

Figure 3 plots the vertical profile of rail irregularity for the simulation of rail geometry variations in this study. The properties of the simple beam are listed in Table 1, in which  $\omega_1$  denotes the fundamental circular frequency of the first mode and  $\omega_n$  the  $n$ -th mode. Twenty sprung mass units are used to model the running train with identical axle-intervals, i.e.,  $N = 20$ . Table 2 shows the properties of the sprung mass units and the first resonant speed ( $v_{res} = \omega_1 d$ ) of the simple beam under the moving loads. The properties of sprung mass units and beam structures listed in Tables 1 and 2 will be employed as the input data for the dynamic response analysis of train-bridge system in the following examples.

$L$ (m)	$EI$ (N-m <sup>2</sup> )	$m$ (t/m)	$c$ (kN-s/m/m)	$\omega_1$ (Hz)
35	$3.1 \times 10^8$	32	40.2	4

Table 1: Properties and natural frequency of the bridge.

$N$	$d$ (m)	$p_0$ (kN)	$m_1$ (t)	$m_2$ (t)	$m_w$ (t)	$c_p$ (kN-s/m)	$k_p$ (kN/m)	$c_s$ (kN-s/m)	$k_s$ (kN/m)	$v_{res} = \omega_1 d$ (km/h)
20	19	272	4	22	1.8	100	1550	50	550	274

Table 2: Properties of sprung mass unit.

#### 4.1 Resonance response

It was well known that if the *acceleration response*, rather than the displacement response, of the bridge is of concern, as is the case considered herein, much more higher modes have to be included in the computation [1,2]. In order to verify that a sufficient number of modes of vibration has been used in the analysis, we first compute the mid-span acceleration response of a *single-span* simple beam with smooth surface under the action of a series of moving sprung mass units given in Table 2 at the first resonant speed of  $v_{res} = \omega_1 d$  ( $= 76\text{m/s} \approx 274\text{km/h}$ ) using either 2, 10, or 20 modes by using the time step of 0.001s. Figure 4 shows the time history response of mid-span acceleration of the beam. As can be seen from Figure 4, the use of 20 modes is considered sufficient. For this reason, the same number of modes and the time step will be used in all the examples to follow. As it is expected for resonance phenomena, the mid-span acceleration response is generally built up as the increase of moving loads passing through the beam. In addition, the time-history responses of vertical acceleration for both the first and the last ( $N = 20$ ) sprung masses have been drawn in Figure 5, respectively. Due to the *resonance* phenomenon occurring in the vibrating beam, the dynamic response of the last sprung mass ( $N = 20$ ) running on the beam has been dramatically amplified in comparison with that of the first one.

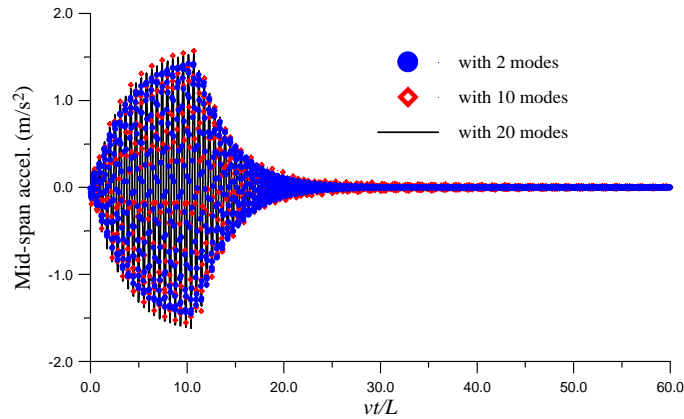

Figure 4: Resonant response of mid-span acceleration.

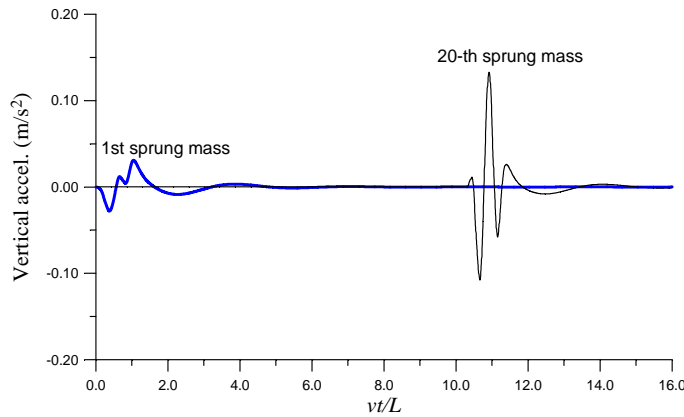

Figure 5 Vertical acceleration of sprung masses moving on a simple beam with smooth surface.

### 4.2 Effect of ground settlement

To explore the influence of ground settlement on the interaction response of vehicle-bridge system, two vertical settlement profiles along the route of the multi-span bridges have been plotted in Figure 6, respectively. Settlement type 1 represents an uneven ground surface settlement along a rail route, and type 2 a simulation of *concave-up* settlement profile caused by regional land subsidence due to the possibility of over groundwater utilization for agricultural and fishery farming use. Let the train loads travel over the multi-span beams from 100 km/h to 500 km/h with an increment of 5km/h. Figure 7 depicts the maximum acceleration response curves at the midpoint of the 15-th beam against various speeds. From the analysis results, the influence of differential settlement on bridge response are generally insignificant since a simple beam with vertical support settlement merely experiences a rigid body displacement or rotation (see Eq. 11), from which there is no additional natural deformation occurring in the beam. Besides, there exist another three sub-resonant peaks plotted in Figure 7 together with secondary peaks at the speeds of 352, 410, and 492 km/h, respectively, which are equal to the sub-resonant speeds at the third mode excited [7], i.e.,  $v_{res} = \omega_3 d / j \Big|_{j=7,6,5}$ . Here  $j$  represents the number of complete oscillation cycles for the third mode of the beam to vibrate during the passage of two adjacent sprung mass units [8].

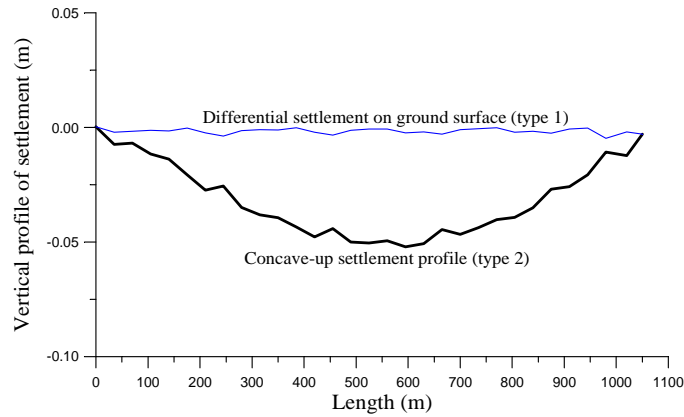

Figure 6: Vertical profile of settlements.

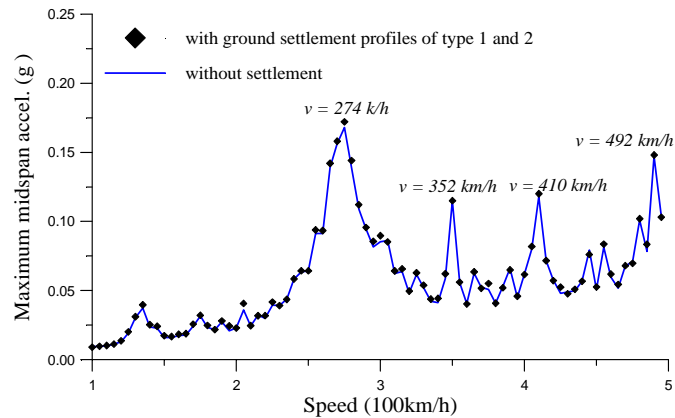

Figure 7: Maximum acceleration for mid-span beam.

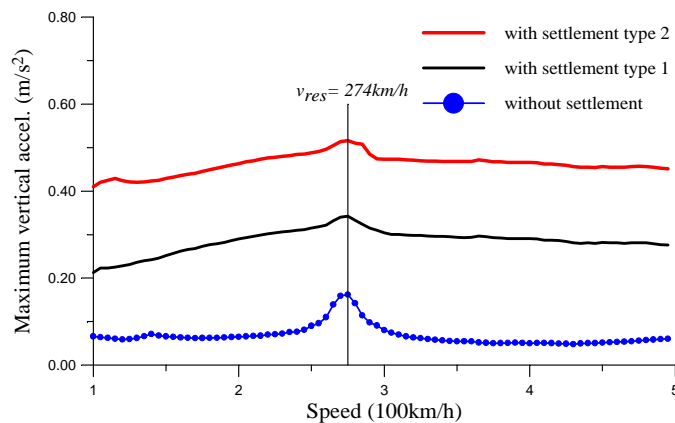

Figure 8: Effect of ground settlement on maximum acceleration of moving vehicles.

For the present example, the maximum vertical acceleration computed for the running train *vs.* the speed has been plotted in Figure 8. Obviously, the inclusion of ground settlement can result in the vehicle’s acceleration amplitude amplifying significantly, particularly for the critical case of the ground settlement type 2 with *concave-up* profile. And there exists a noticeable amplification for each of the response curves at the resonant speed of 274km/h. It means that as a train travels over multi-span bridges that have to cross the region with local land subsidence, the operation speed should be kept away from the resonant speed for running safety of the moving train. Since the present sprung mass unit is a rather simplified vehicle



model, a further study to develop a more realistic 3D train model is required for carrying out the dynamic interactions of the train-bridge system undergoing ground settlement.

## 5 Concluding remarks

To deal with the dynamic problem of a beam structure with differential support settlement, a *decomposition* method is proposed to extract the static displacement from the total response of the beam. Then, the dynamic response of the vehicle-bridge coupling system is solved by Galerkin's method and computed using an iterative approach with the Newmark finite difference formulas. From the numerical studies, the following conclusions are reached:

- (1) Once the resonance occurs in the vehicle-bridge interaction system around the resonant speed, the dynamic responses of both the bridge and train are amplified dramatically.
- (2) With the allowable angular distortion not exceeding 1/1000 for high-speed railway bridges built in the region with local land subsidence, the effect of differential settlement has little influence on the bridge response induced by moving trains.
- (3) With the inclusion of support settlement, especially for the *concave-up* settlement profile, the maximum accelerations of a traveling train are totally amplified even though the running speeds are not in the range of resonant speeds.

## Acknowledgements

This research was partly sponsored by grants of (102-2221-E-019-042 and 103-2918-I-032-001) from the *Ministry of Science and Technology* in Taiwan.

## References

- [1] Yau JD. *Vibration of arch bridges due to moving loads and vertical ground motions*, J Chinese Institute Engineers 2006;29:1017–27.
- [2] Yau JD, Fryba L. *Response of suspended beams due to moving loads and vertical seismic ground excitations*, Eng Struct 2007;29:3255–3262.
- [3] Clough RW, Penzien J. *Dynamics of structures*. New York: McGraw Hill; 1975.
- [4] Newmark NM. *A method of computation for structural dynamics*, J Eng Mech Div, ASCE 1959;85(1):67–94.
- [5] THSR. *Taiwan high speed rail project—design specification for civil works, Addendum Number 1*, Taiwan High Speed Rail Corporation; 1999.
- [6] Yang YB, Kuo SR. *Theory and analysis of nonlinear framed structures*. Singapore: Prentice Hall; 1994.
- [7] Xia H, Zhang N, Guo WW. *Analysis of resonance mechanism and conditions of train-bridge system*, J Sound Vib 2006;297:810–822.
- [8] Museros P, Alarcón E. *Influence of the second bending mode on the response of high-speed bridges at resonance*, J Struct Eng, ASCE 2005;131(3):404–15.
- [9] Yau JD, Yang YB. *Vertical accelerations of simple beams due to successive loads traveling at resonant speeds*, J Sound Vib 2006;289:210–228.

